

ALKALINE-MANGANESE DIOXIDE BATTERY



Size: D – PC1300

IEC: LR20 | ANSI: 13A

KEY FEATURES

- Reliable Performance
- Resistance to corrosion
- Designed to meet all major quality, safety and environmental standards:
 - Safety: IEC 60086-5
 - ANSI C 18.1M, Part-2
 - EU Battery Directive
 - Quality: ISO 14001 and 9001, Duracell World Class Continuous Improvement Program

TYPICAL APPLICATIONS

- Clocks
- Multimeters
- Flashlights
- Scales

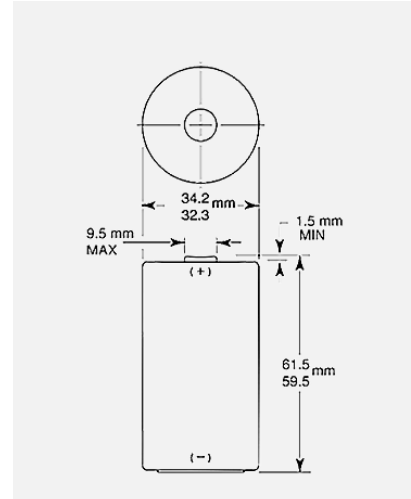

Dimensions shown are ANSI/IEC standards

ELECTRICAL CHARACTERISTICS

- | | |
|---|------------|
| ▪ Nominal capacity (25 mA cont., .8V cut-off) | 19,000 mAh |
| ▪ Typical Voltage (at + 20 °C) | 1.5 V |
| ▪ AC Impedance @ 1kHz | 85 mΩ |

PHYSICAL CHARACTERISTICS

- | | |
|------------------|---|
| ▪ Typical weight | 141.0 g (4.97 oz) |
| ▪ Typical volume | 56.4 cm ³ (3.4 in ³) |
| ▪ Terminals | Flat |

OPERATING & STORAGE CONDITIONS

- | | |
|--|----------------------------------|
| ▪ Operating temperature range | -20°C to 54°C
(-4°F to 130°F) |
| ▪ Recommended storage temperature
(storage area should be clean, cool, dry
and ventilated) | 6°C to 29°C
(42°F to 85°F) |
| ▪ Storage relative humidity | 26%-80% RH |

Delivered capacity is dependent on the applied load, operating temperature and cut-off voltage. Please refer to the charts and discharge data shown for examples of the energy/service life that the battery will provide for various load conditions.

This data is subject to change. Performance information is typical. Contact Duracell for the latest information.

TYPICAL PERFORMANCE

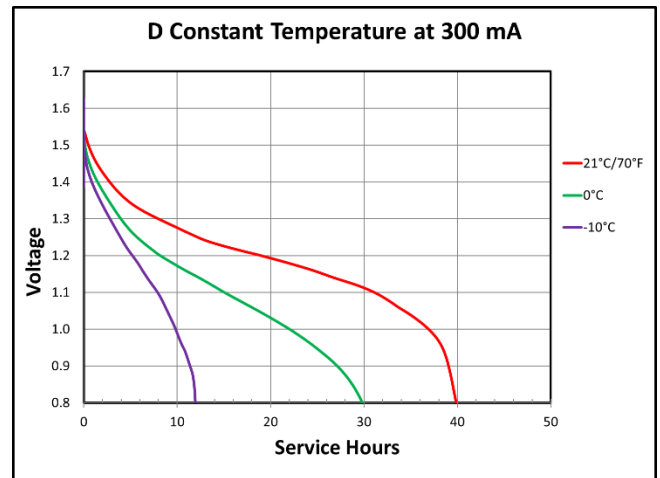
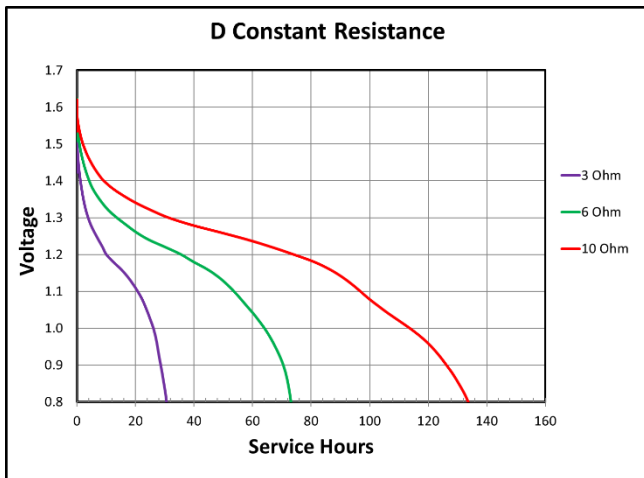
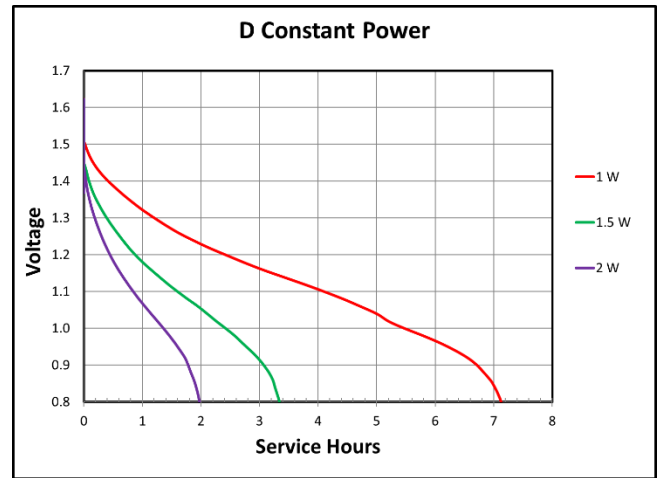
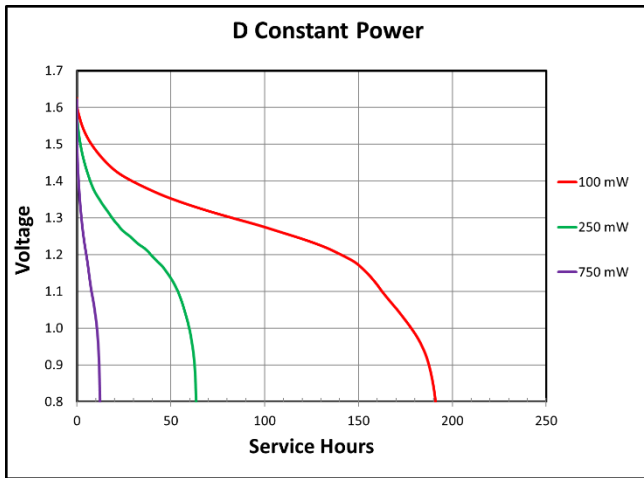
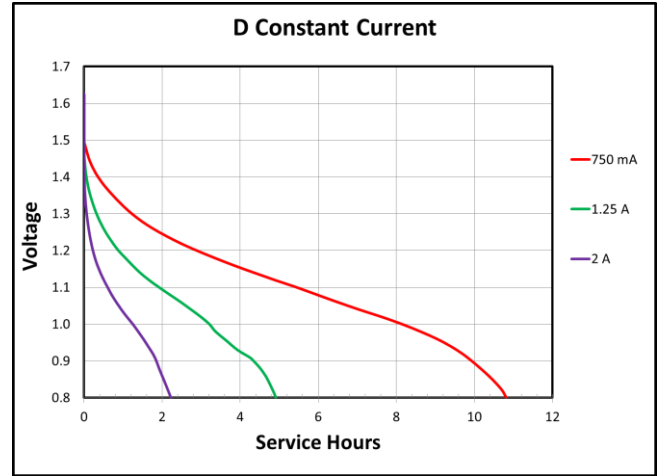
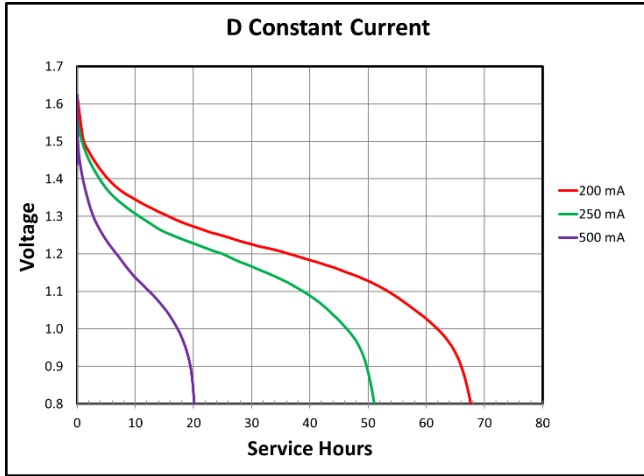

Delivered capacity is dependent on the applied load, operating temperature and cut-off voltage. Please refer to the charts and discharge data shown for examples of the energy/service life that the battery will provide for various load conditions.

This data is subject to change. Performance information is typical. Contact Duracell for the latest information.

LR56178